

WARNING! - Please Read this Information Carefully:

The project described in these pages utilizes **POTENTIALLY FATAL HIGH VOLTAGES**. If you are in any way unfamiliar with high voltage circuits or are uncomfortable working around high voltages, **PLEASE DO NOT RISK YOUR LIFE BY BUILDING THEM**. Seek help from a competent technician before building any unfamiliar electronics circuit. While efforts are made to ensure accuracy of these circuits, no guarantee is provided, of any kind!

USE AT YOUR OWN RISK: THE WEBMASTER, PROJECT COORDINATOR, PROJECT CONTRIBUTORS AND WEB SPACE PROVIDER EXPRESSLY DISCLAIM ALL LIABILITY FOR INJURY OR PROPERTY DAMAGE RESULTING FROM THIS INFORMATION! ALL INFORMATION IS PROVIDED 'AS-IS' AND WITHOUT WARRANTY OF ANY KIND.

COPYRIGHT AND INTELLECTUAL PROPERTY NOTICE:

The content of this document is protected by the copyright laws of the United States of America and the international copyright laws and agreements.

Except where specifically noted, Cliff Chappell or Chris Hurley owns (or has permission to use) all intellectual property rights in relation to this document and its content (including, but not limited to, all trademarks and copyright).

No part of the document may be reproduced, displayed, copied, translated, adapted, downloaded, broadcast, used or republished in any form including (without limitation) distribution, or storage in a system for retrieval.

Revision	Description
08.06.16	Corrected S5 Wiring Added "As-built" Voltages Changed Values Of R3, R4, R5, & R12 Change R36 And R37 To 249K Changed R12 To 33K
08.08.03	Missing Wire On Chassis Layout Corrected PI Voltage Readings Removed Rx1 And Changed Rx2 To 56K
08.12.24	Added Optional RfC And RfD Removed Series/Parallel Switch Added Optional Hammond 125E
09.01.08	Changed VR9 And VR10 Standardized VR Labels

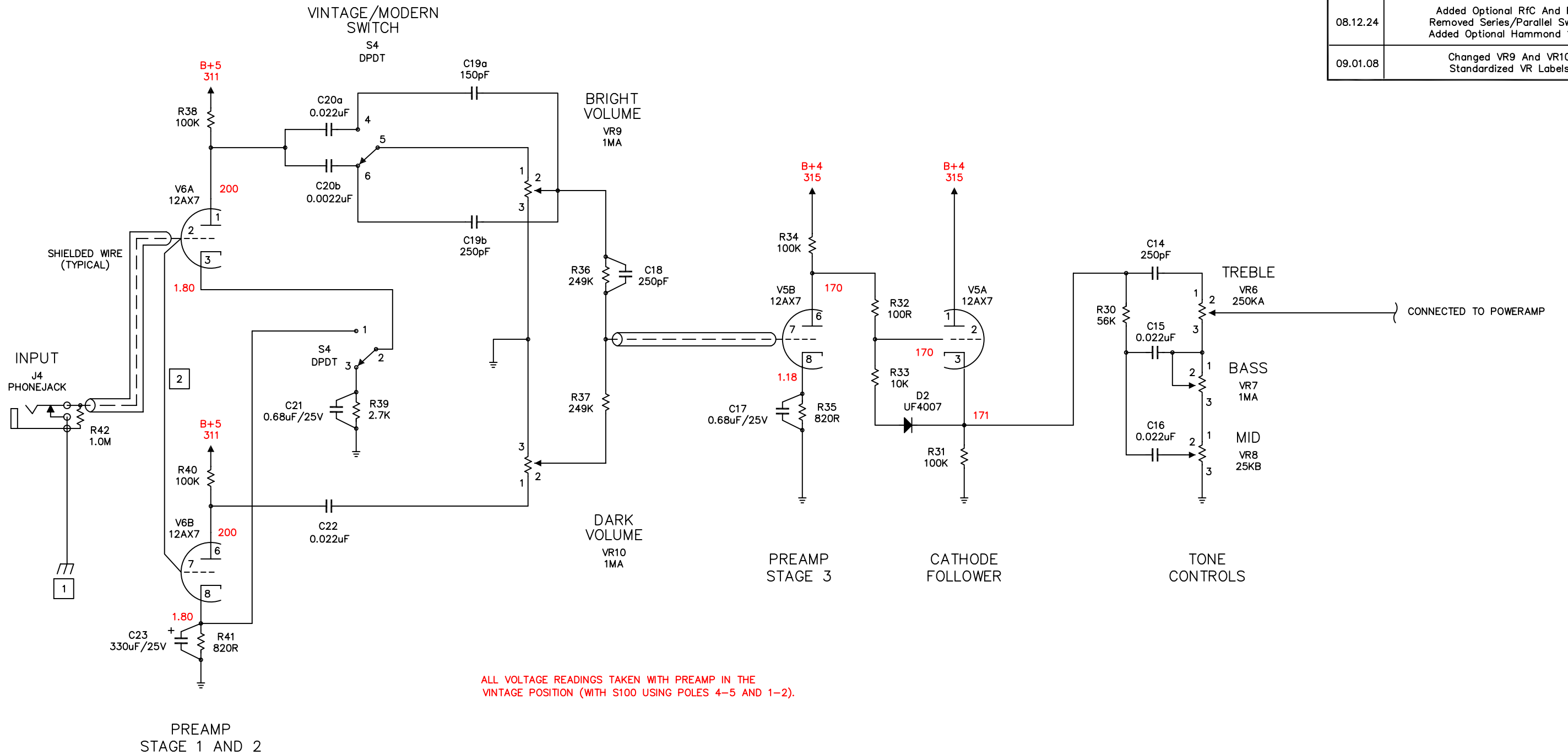

Revision	Description
08.06.16	Corrected S5 Wiring Added "As-built" Voltages Changed Values Of R3, R4, R5, & R12 Change R36 And R37 To 249K Changed R12 To 33K
08.08.03	Missing Wire On Chassis Layout Corrected PI Voltage Readings Removed Rx1 And Changed Rx2 To 56K
08.12.24	Added Optional RfC And RfD Removed Series/Parallel Switch Added Optional Hammond 125E
09.01.08	Changed VR9 And VR10 Standardized VR Labels

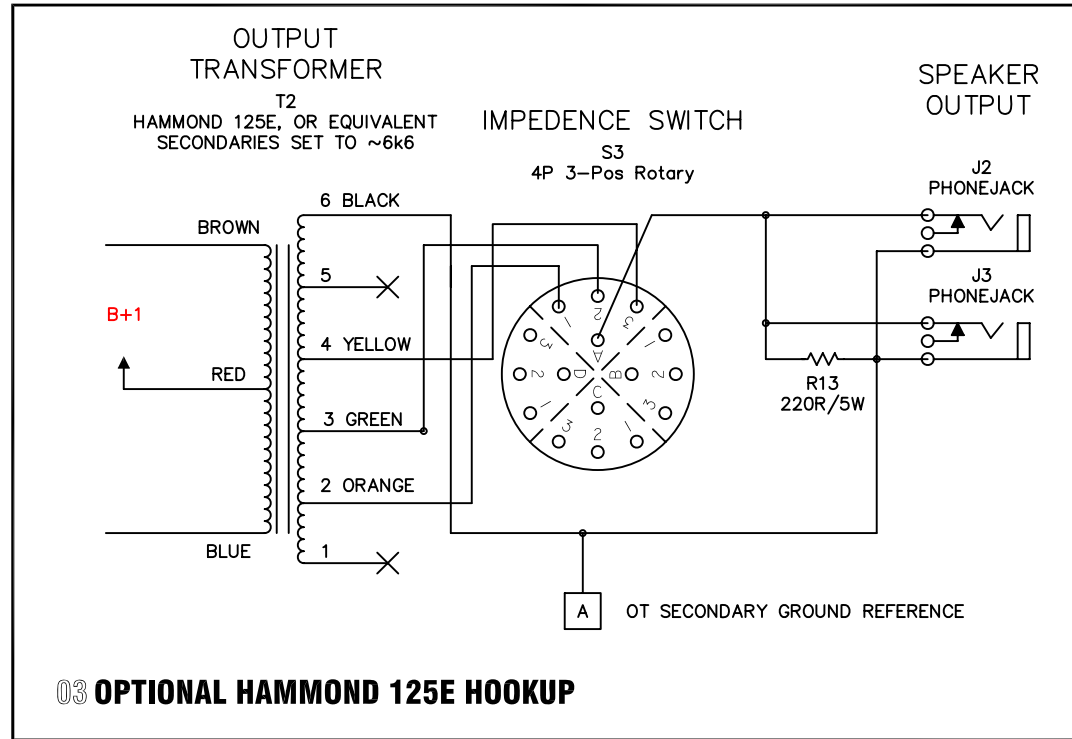
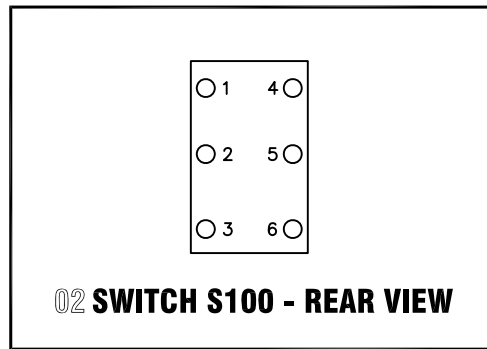
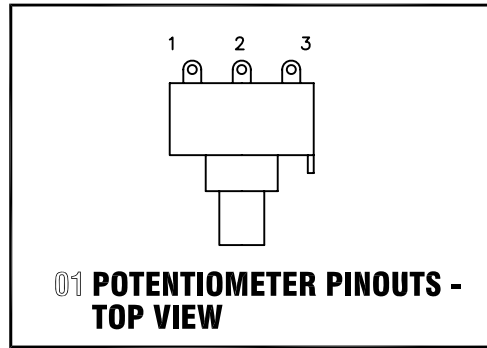

GENERAL NOTES:

1. ALL RESISTORS 1/2W MINIMUM UNLESS OTHERWISE NOTED.
2. ALL COUPLING CAPACITORS 400V OR GREATER.
3. VOLTAGE READINGS ARE THOSE TAKEN WITH 6V6-S. THE USE OF OTHER OUTPUT TUBES WILL ALTER YOUR READINGS.
4. THE  SYMBOL REPRESENTS SHIELDED CABLE.

CONSTRUCTION NOTES:

- 1 THIS IS A GROUND CONNECTION TO THE CHASSIS. THE MAINS SAFETY CONNECTION SHOULD BE MADE AS CLOSE AS POSSIBLE TO THE POINT WHERE AC ENTERS THE CHASSIS. THE CIRCUIT CONNECTION SHOULD BE MADE AS CLOSE AS POSSIBLE TO THE INPUT JACK. IDEALLY, THE JACK ITSELF SHOULD BE USED AS THE CONNECTION POINT BY NOT ISOLATING IT FROM THE CHASSIS.
- 2 THESE TWO 0.1R/5W RESISTORS ARE OPTIONAL, AND ARE NEEDED ONLY WHEN YOUR MAINS VOLTAGES ARE GREATER THAN THAT WHICH THE POWER TRANSFORMER WAS WOUND FOR. THE VALUES SHOWN SHOULD BE CORRECT FOR A 115V PT USED WITH 120V MAINS. THE PURPOSE OF THESE TWO RESISTORS IS TO INSURE THAT THE FILAMENT VOLTAGE STAYS WITHIN +/- 10% OF 6.3VAC.

VOLTAGE READING NOTES:

1. THE VOLTAGE READINGS ON THIS SCHEMATIC ARE SIMULATED BASED ON THE USE OF A HAMMOND 270FX WITH 120V MAINS.
2. DIFFERENT TUBES DRAW DIFFERENT AMOUNTS OF CURRENT, NO TWO ARE ALIKE UNLESS THEY ARE MATCHED. THE AMOUNT OF CURRENT DRAWN BY ALL THE TUBES IN THE AMP WILL AFFECT VOLTAGE READINGS THROUGHOUT THE AMP.

AX84 October Club Amplifier BOM

Revision: 09.01.08

Item	Quantity	Reference	Value
1	1	C1	47uF/450V
2	1	C2	40/20/20/20 Multi-section Capacitor
3	3	C6, C7, C8	10uF/160V
4	7	C9, C10, C11, C15, C16, C20a, C22	0.022uF/400V
5	2	C12, C13	0.1uF/100V
6	3	C14, C18, C19b	250pF/500V
7	2	C17, C21	0.68uF/25V
8	1	C19a	150pF/500V
9	1	C20b	0.0022uF/400V
10	1	C23	330uF/25V
11	2	R1, R2	50R/5W
12	2	RfA, RfB	0.1R/5W
13	2	RfC, RfD	100R
14	1	R3	3K/2W
15	2	R4, R5	1k5/1W
16	2	R6, R8	180K/1W
17	1	R7	47K/1W
18	1	R9	15K/1W
19	2	R10, R11	68K
20	2	R12	33K
21	1	R13	220R/5W
22	2	R14, R15	5k6
23	2	R16, R17	1K/5W
24	2	R18, R19	1R/1%
25	8	R20, R21, R23, R29, R31, R34, R38, R40	100K
26	1	R22	82K
27	3	R24, R26, R42	1.0M
28	1	R25	470R
29	2	R27, R28	22K
30	1	R30	56K
31	3	R32, RfC, RfD	100R
32	1	R33	10K
33	2	R35, R41	820R
34	2	R36, R37	249K
35	1	R39	2k7
36	1	F1	1A SLO-BLO
37	1	FH1	Fuse Holder
38	1	J1	Power Connector
39	1	PC1	Power Cord
40	3	J2, J3, J4	Phonejack
41	4	JW1, JW2, JW3, JW4	Phonejack Isolation Washer (if needed)
42	2	S1, S4	SW DPDT
43	1	S2	SW SPST
44	2	D1, D2	UF4007

45	1	PL1	Pilot Lamp Assembly And Bulb
46	1	T1	Hammond 270EX
47	1	T2	Hammond 1750E
48	1	L1	Hammond 156G
49	3	SK4, SK5, SK6	9 Pin Tube Sockets
50	3	SK1, SK2, SK3	8 Pin Octal Socket
51	1	V1	GZ34/5AR4
52	2	V2, V3	6V6GT
53	3	V3, V4, V5	12AX7
54	2	VR1, VR2	25KB (bias)
55	1	VR3	100KB
56	1	VR4	5KB
57	4	VR5, VR7, VR9, VR10	1MA
58	1	VR6	250KA
59	1	VR8	25KB
60	1	CCImp	Clamp For Multi-section Cap C2
61	8	K1, K2, K3, K4, K5, K6, K7, K8	Front Panel Knobs
62	1	K9	Impedence Selector Knob
63	1	CH1	Chassis
64	2	TP1, TP2	Red Tip Jack
65	1	TP3	Black Tip Jack
66	2		3-lug Terminal Strip

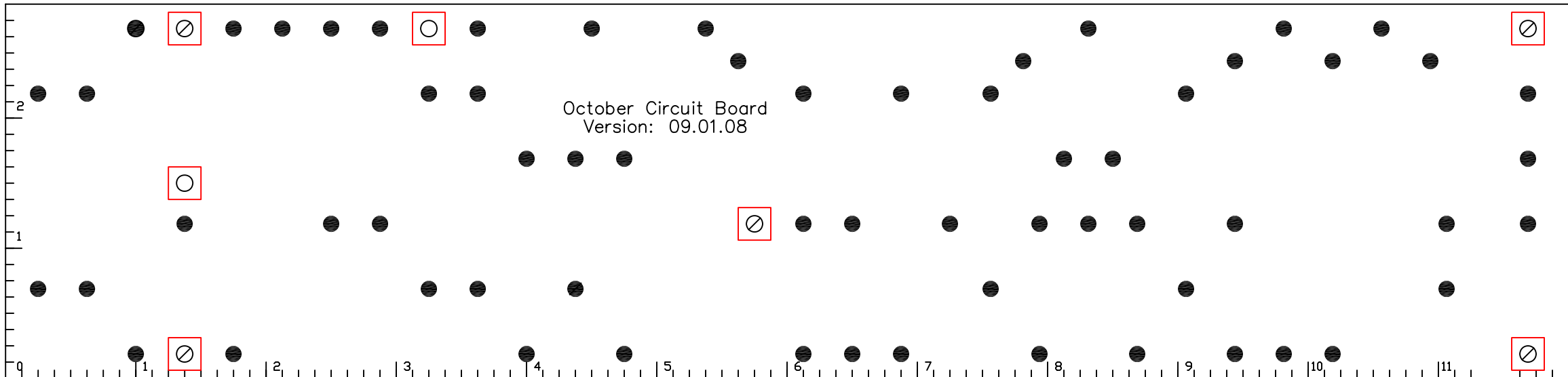

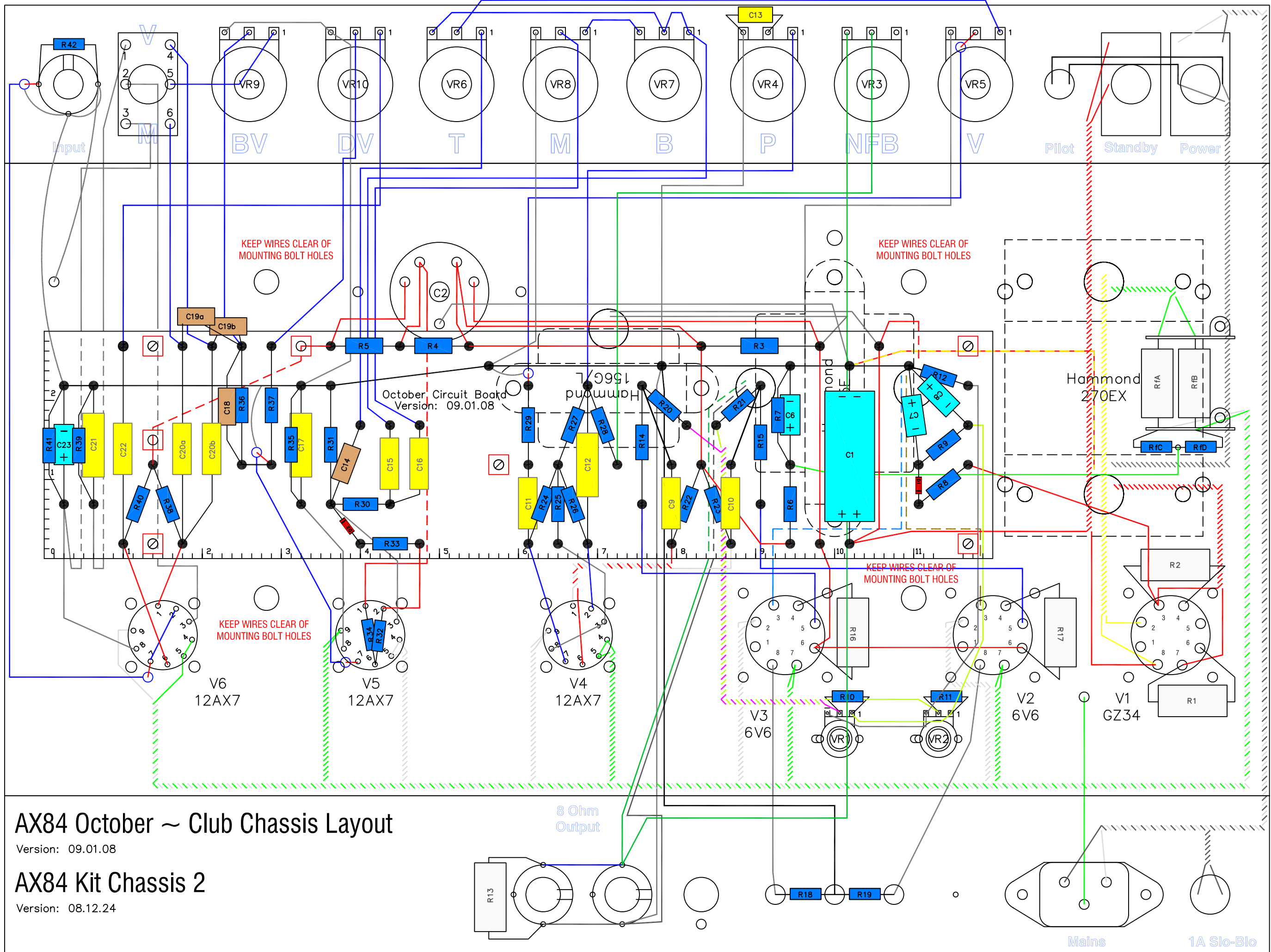

AX84 October ~ Club Chassis Layout

Version: 09.01.08

AX84 Kit Chassis 2

Version: 08.12.24

8 Ohm Output

Mains

1A Slo-Blo